

LISTE OVER TEGNINGER

Beskrivelse		Dato		
Cedral Lap - Lodret montering Detaljer		2024-06-19		
		Sidste rev. dato		
Tegningsnummer	Beskrivelse	Skala	Dato	Rev. dato
CL00	Placering afstandliste gavl / væg	-	20240619	
CL01	Profiler Cedral Lap – Vandret montering	1:2	20240619	
CL02	Startprofil vandret montering Jordniveau	1:2	20240619	
CL03	Sålbænk detalje	1:2	20240619	
CL04	Vandnæse vindue - startprofil	1:2	20240619	
CL04A	Vandnæse vindue - alternativ	1:2	20240619	
CL04B	Vandnæse vindue - alternativ	1:2	20240619	
CL05	Top facade mod beton/sten	1:2	20240619	
CL05A	Top facade mod underbeklædning	1:2	20240619	
CL06	Standard montage	1:2	20240619	
CL07	Symetrisk udvendigt hjørne	1:2	20240619	
CL08	Sideinddækning vindue	1:2	20240619	
CL08A	Asymmetrisk utvendig hjørne - vindue	1:2	20240619	
CL09	Invendigt hjørne	1:2	20240619	
CL10	Dobbelt endekant profil	1:2	20240619	
CL11	Stern	1:2	20240619	

For yderligere oplysninger, kontakt venligst :

Tel: +45 73 66 19 99 | E-mail: etexnordic-dk@etexgroup.com | www.cedral.world
Etex Nordic A/S | Vendersgade 74 | DK-7000 Fredericia



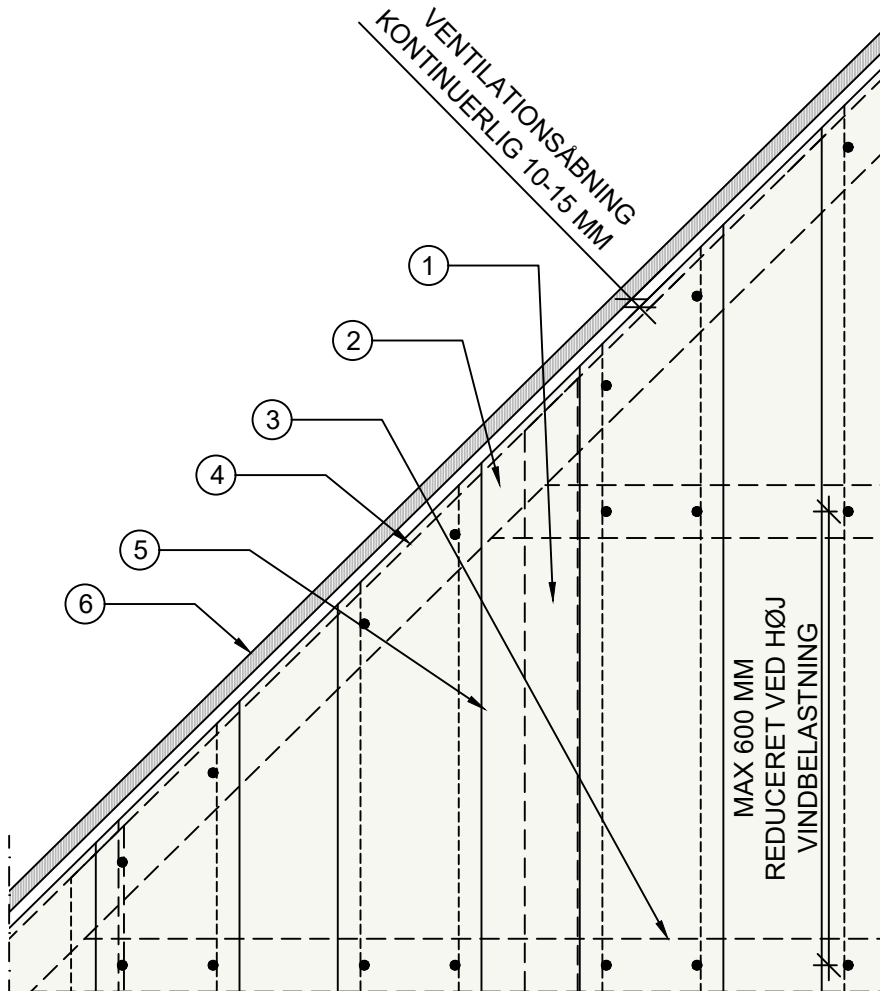

- ① UNDERKONSTRUKTION 25x50/25x100 LODRET - INDRE LAG
- ② UNDERKONSTRUKTION 25x100 FØLGER TAGHÆLDNING - YDRE LAG
- ③ UNDERKONSTRUKTION 25x50/25x100 VANDRET - YDRE LAG MAX C/C 600 MM
- ④ PERFORERET VENTILATIONSPROFIL [4017076, 4017078]
- ⑤ CEDRAL LAP
- ⑥ UNDERBEKLÆDNING

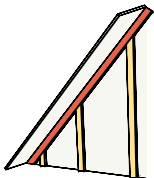
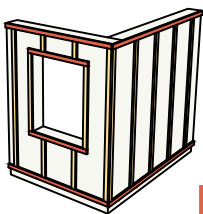
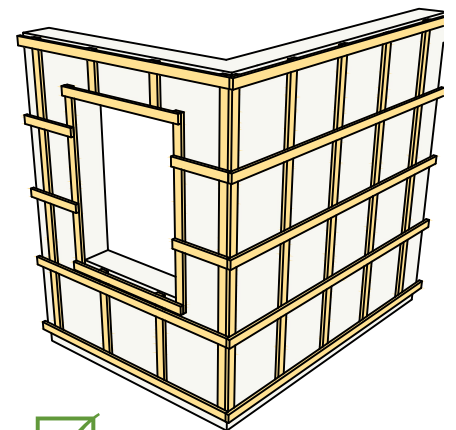
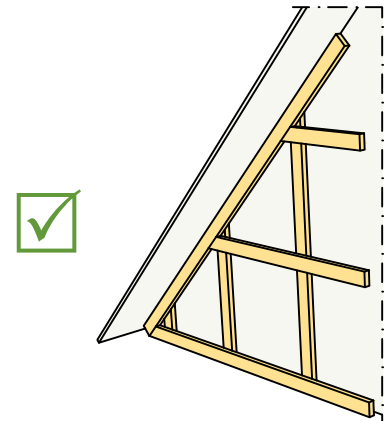

VID KRYDSFORSKALING SKAL LÆGTER I AFSLUTNING, VINDUER OSV. ALDRIG LAVES I DET FØRSTE LAG VANDRET, MEN PÅ DE LODRETTE LÆGTER OG AFSLUTTES 15-20 MM FRA ÅBNINGEN/AFSLUTNINGEN FOR AT SIKRE UDLUFTNING [INDLØB/UDLØB].

Copyright

This information is supplied in good faith but no liability can be accepted for any loss or damage resulting from use. All details and quantities must be checked and approved prior to order.

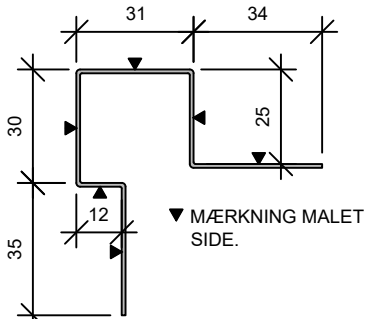

ASYMMETRISK
UTVENDIG HJØRNE PROFIL

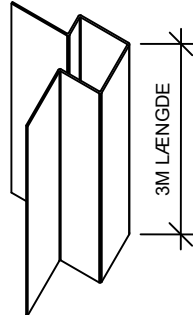

▼ MÆRKNING MALET
SIDE.

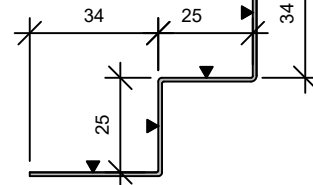

INVENDIGT HJØRNE PROFIL

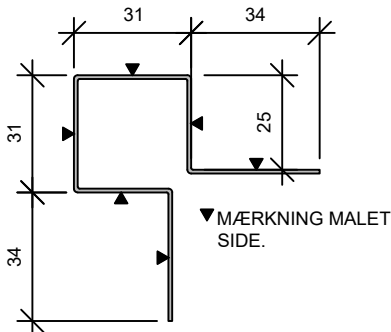
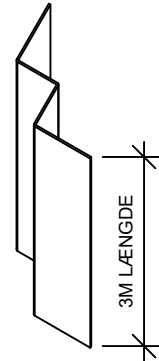

SYMMETRISK
UTVENDIG HJØRNE PROFIL

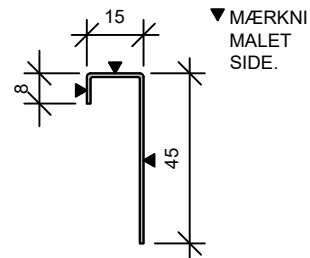
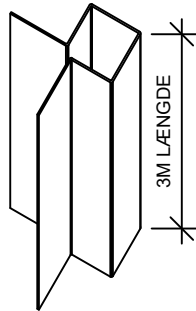

ENKEL ENDEKANT PROFIL

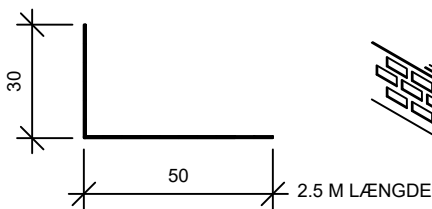
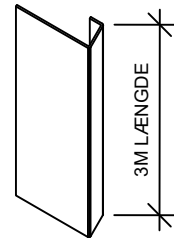

SOKKELSIKRING
ART. NR. 4017078 - UBEHANDLET
ART. NR. 4017076 - SORT

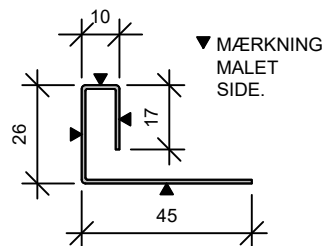

DOBBELT ENDEKANT PROFIL

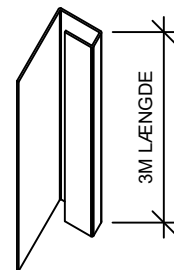

- ① KRYDSFORSKALING AFSTANDSLISTE
25x100/25x50
- ② CEDRAL LAP
- ③ SQD SKRUE 4,2x45 [4034483]
- ④ SYNLIG I-FIX TRÆSKRUE 4,8x60
- ⑤ ALU SOKKELSIKRING [4017076, 4017078]

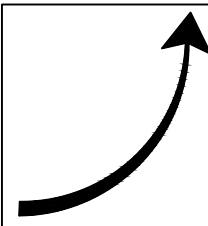
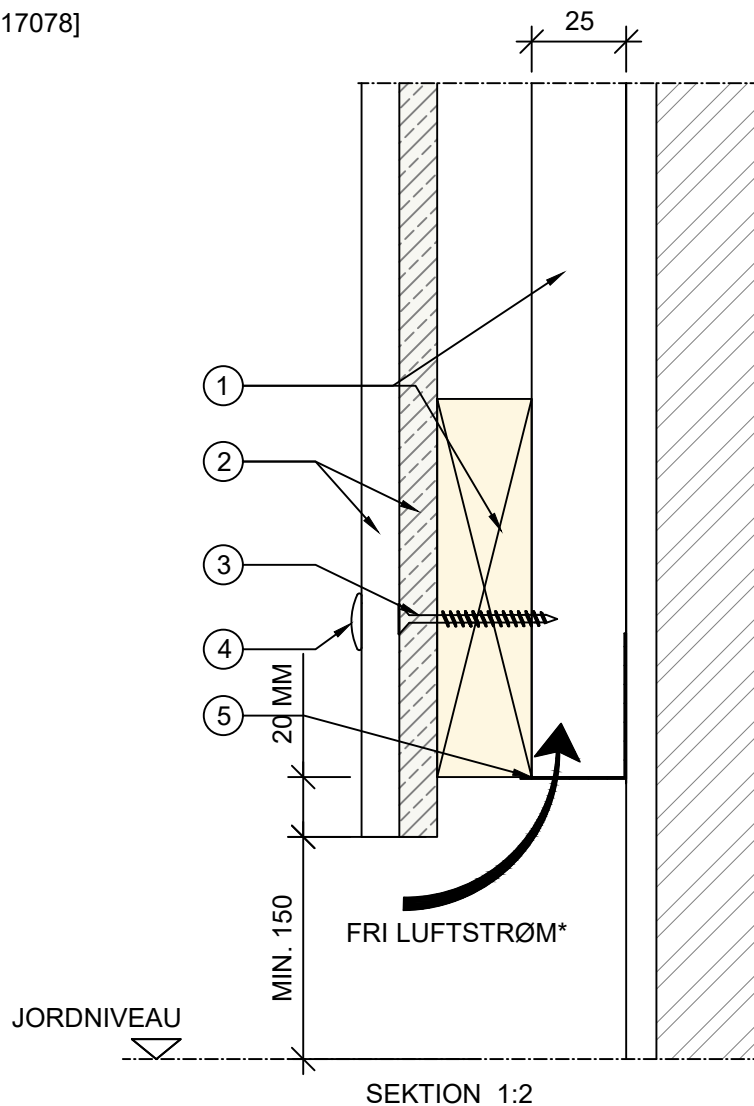

* FRI KONTINUERLIG LUFTSTRØM
MINIMUM 100 CM²/M KONTINUERLIG ÅBNING VED
INDLØBET/UDLØB - ANBEFALET 10-15 MM

FOR YDERLIGERE INFORMATION, VENLIGST KONTAKT:

INTERNET: WWW.CEDRAL.WORLD E-MAIL: etexnordic-dk@etexgroup.com TEL: +45 73 66 19 99

ETEX NORDIC A/S, VENDERSGADE 74, DK-7000 FREDERICIA

- ① ALU SOKKELSIKRING [4017076, 4017078]
- ② SYNLIG I-FIX TRÆSKRUE 4,8x60
- ③ SQD SKRUE 4,2x45 [4034483]
- ④ KRYDSFORSKALING AFSTANDSLISTE 25x100/25x50
- ⑤ CEDRAL LAP

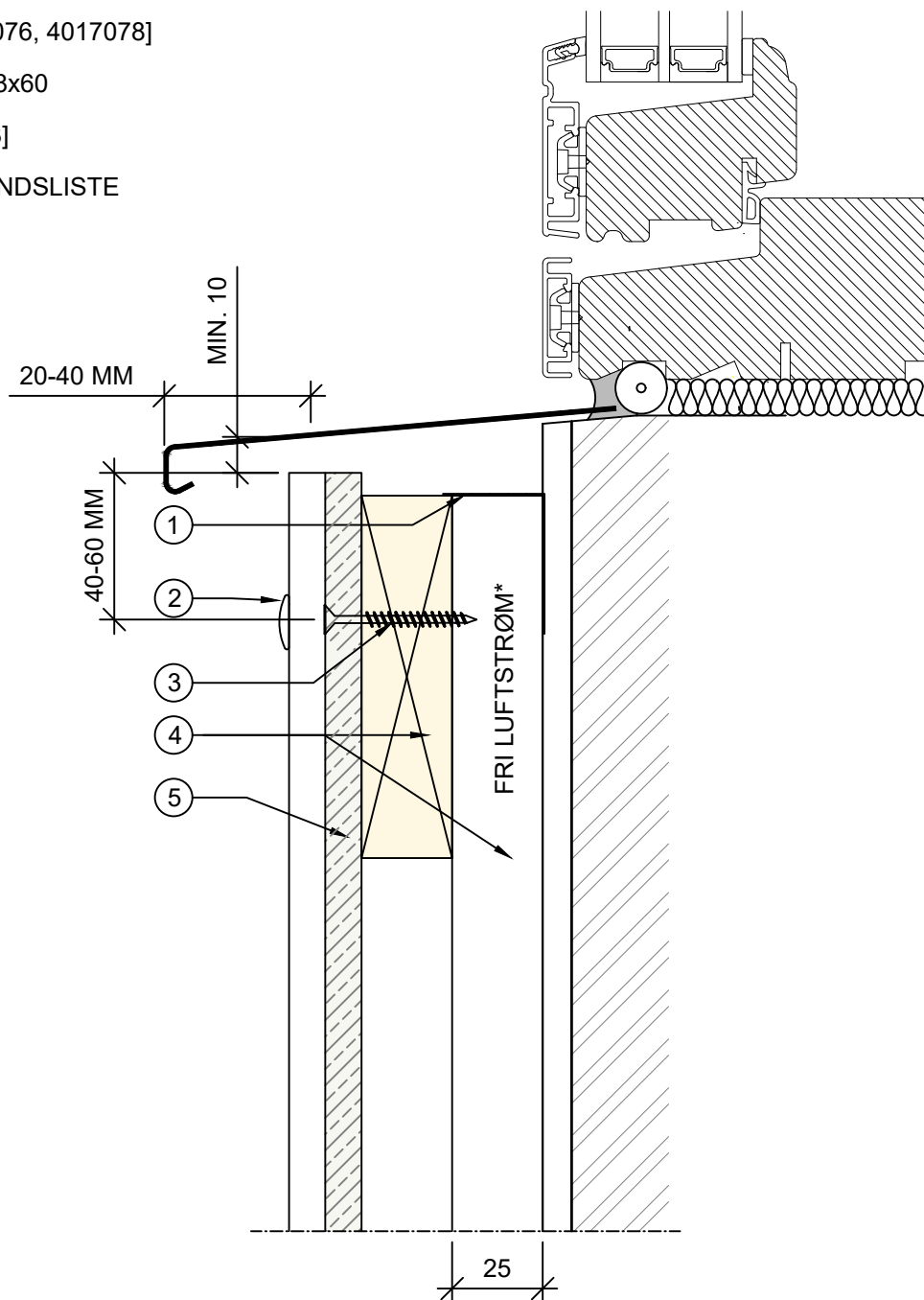

* FRI KONTINUERLIG LUFTSTRØM
 MINIMUM 100 CM²/M KONTINUERLIG ÅBNING VED
 INDLØBET/UDLØB - ANBEFALET 10-15 MM

FOR YDERLIGERE INFORMATION, VENLIGST KONTAKT:

INTERNET: WWW.CEDRAL.WORLD E-MAIL: etexnordic-dk@etexgroup.com TEL: +45 73 66 19 99

ETEX NORDIC A/S, VENDERSGADE 74, DK-7000 FREDERICIA

- ① CEDRAL LAP
- ② KRYDSFORSKALING AFSTANDSLISTE
25x100/25x50
- ③ SYNLIG I-FIX TRÆSKRUE 4,8x60
- ④ SQD SKRUE 4,2x45 [4034483]
- ⑤ ALU SOKKELSIKRING [4017076, 4017078]
- ⑥ VANDÆSE

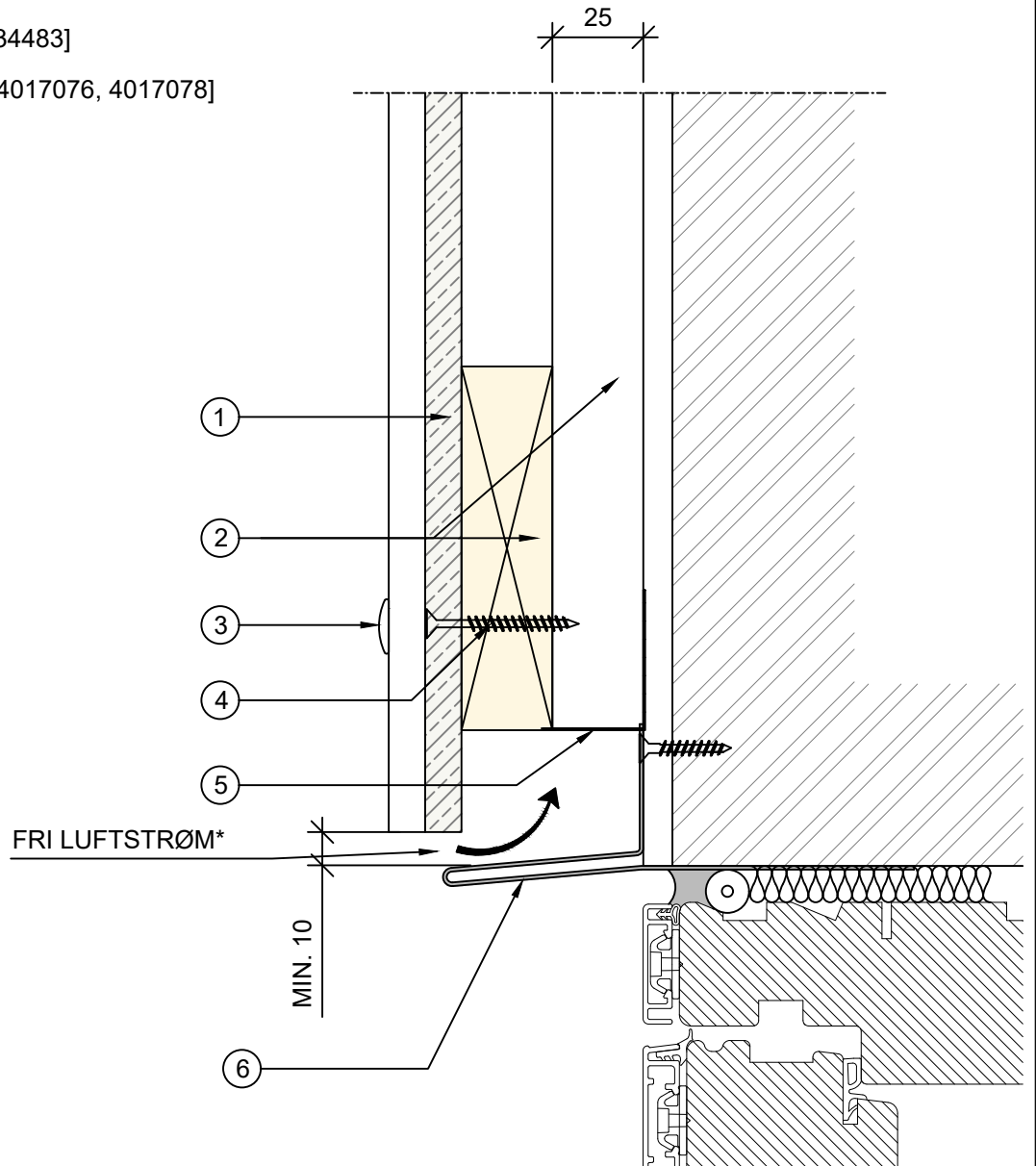

* FRI KONTINUERLIG LUFTSTRØM
MINIMUM 100 CM²/M KONTINUERLIG ÅBNING VED
INDLØBET/UDLØB - ANBEFALET 10-15 MM

CEDRAL

CEDRAL TEGNING

CLV 04

TITEL

TOP FACADE

AF

DKIVPF

DATO

2024.06.19

SKALA

1:2

Copyright

This information is supplied in good faith but no liability can be accepted for any loss or damage resulting from use. All details and quantities must be checked and approved prior to order.

- ① ALU SOKKELSIKRING [4017076, 4017078]
- ② SYNLIG I-FIX TRÆSKRUE 4,8x60
- ③ SQD SKRUE 4,2x45 [4034483]
- ④ KRYDSFORSKALING AFSTANDSLISTE 25x100/25x50
- ⑤ CEDRAL LAP

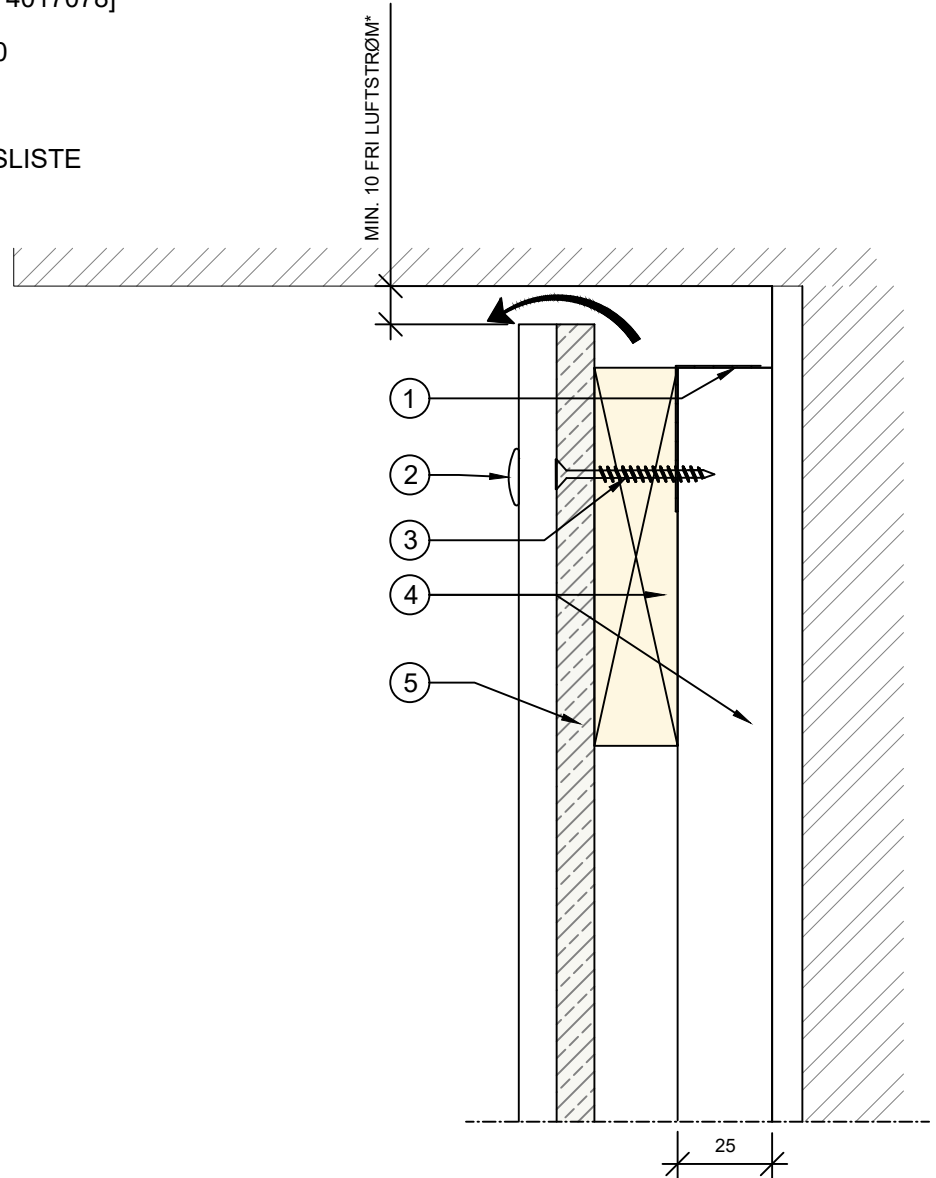

SEKTION 1:2

* FRI KONTINUERLIG LUFSTRØM
MINIMUM 100 CM²/M KONTINUERLIG ÅBNING VED
INDLØBET/UDLØB - ANBEFALET 10-15 MM

FOR YDERLIGERE INFORMATION, VENLIGST KONTAKT:
INTERNET: WWW.CEDRAL.WORLD E-MAIL: etexnordic-dk@etexgroup.com TEL: +45 73 66 19 99
ETEX NORDIC A/S, VENDERSGADE 74, DK-7000 FREDERICIA

Copyright

This information is supplied in good faith but no liability can be accepted for any loss or damage resulting from use. All details and quantities must be checked and approved prior to order.

- ① ALU SOKKELSIKRING [4017076, 4017078]
- ② SYNLIG I-FIX TRÆSKRUE 4,8x60
- ③ SQD SKRUE 4,2x45 [4034483]
- ④ KRYDSFORSKALING AFSTANDSLISTE 25x100/25x50
- ⑤ CEDRAL LAP

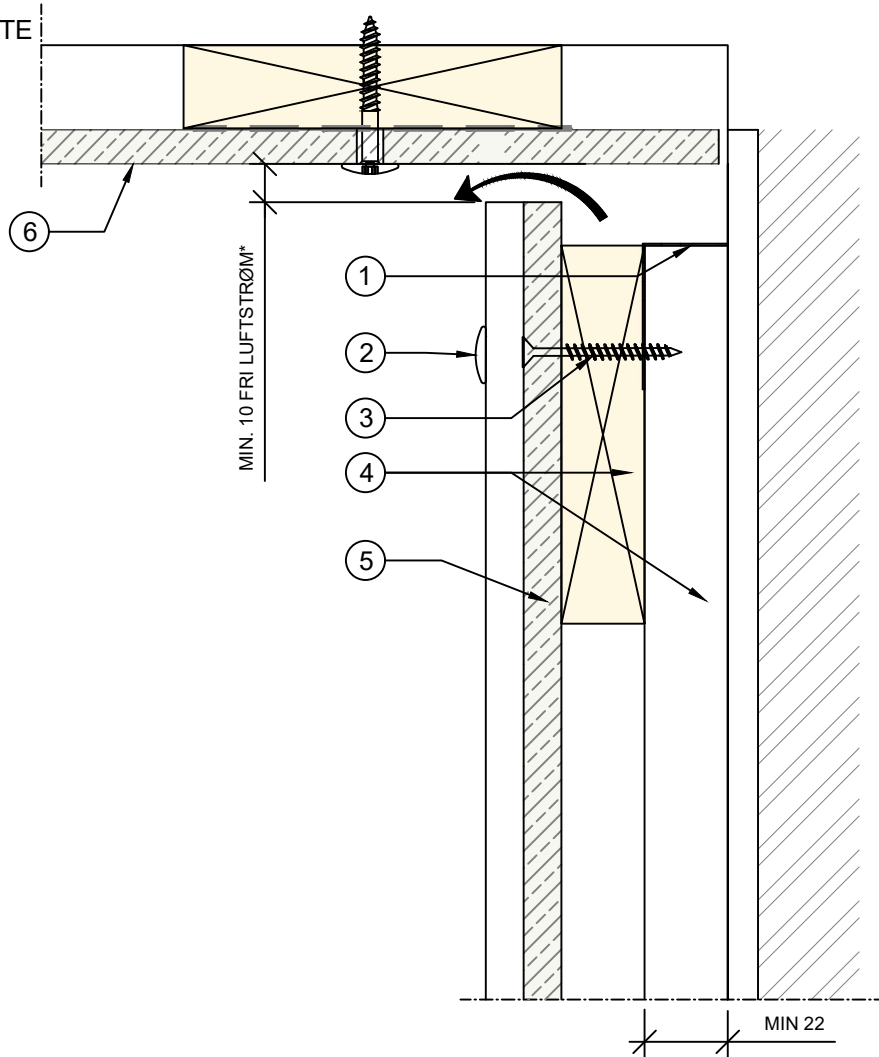

SEKTION 1:2

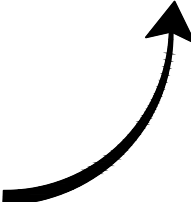
 * FRI KONTINUERLIG LUFSTRØM
MINIMUM 100 CM²/M KONTINUERLIG ÅBNING VED
INDLØBET/UDLØB - ANBEFALET 10-15 MM

FOR YDERLIGERE INFORMATION, VENLIGST KONTAKT:

INTERNET: WWW.CEDRAL.WORLD E-MAIL: etexnordic-dk@etexgroup.com TEL: +45 73 66 19 99

ETEX NORDIC A/S, VENDERSGADE 74, DK-7000 FREDERICIA

Copyright

This information is supplied in good faith but no liability can be accepted for any loss or damage resulting from use. All details and quantities must be checked and approved prior to order.

- ① KRYDSFORSKALING AFSTANDSLISTE
25x100/25x50
- ② CEDRAL LAP
- ③ SYNLIG I-FIX TRÆSKRUE 4,8x60
- ④ SQD SKRUE 4,2x45 [4034483]

*MED FORDEL FORBORET MED
ET 4 MM BOR

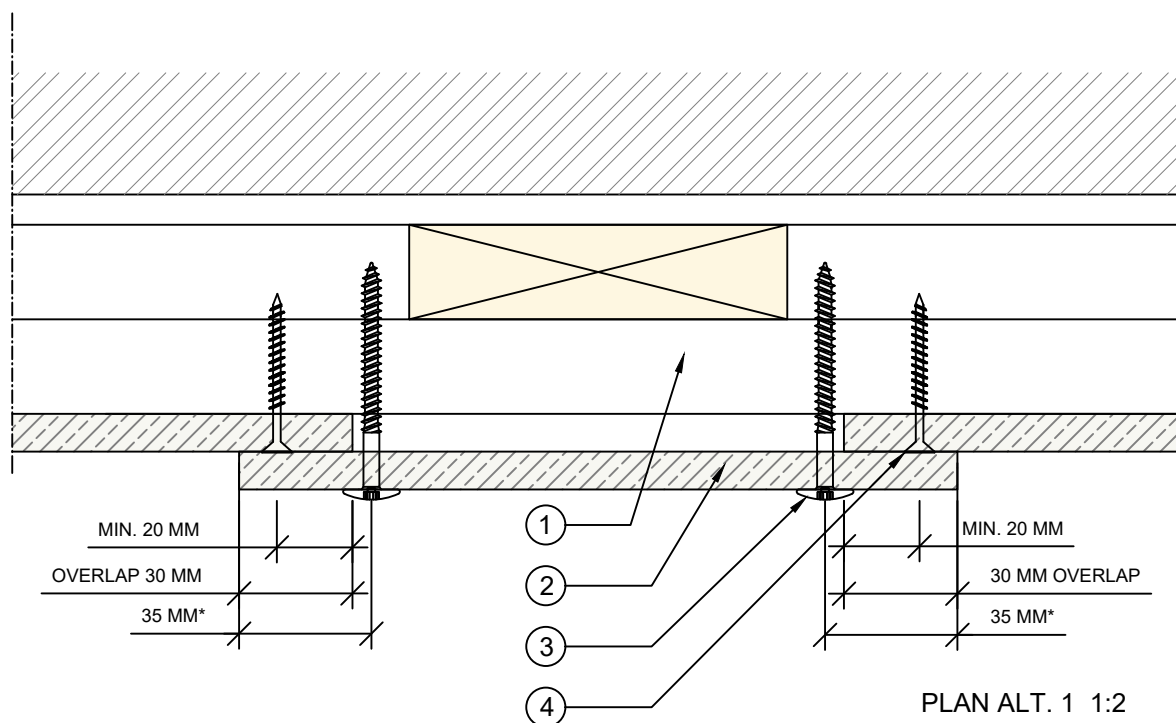

FOR YDERLIGERE INFORMATION, VENLIGST KONTAKT:

INTERNET: WWW.CEDRAL.WORLD E-MAIL: etexnordic-dk@etexgroup.com TEL: +45 73 66 19 99

ETEX NORDIC A/S, VENDERSGADE 74, DK-7000 FREDERICIA

Copyright

This information is supplied in good faith but no liability can be accepted for any loss or damage resulting from use. All details and quantities must be checked and approved prior to order.

- ① SYMMETRISK UDVENDIGT HJØRNE
- ② CEDRAL LAP
- ③ CEDRAL LAP - PASSTYKK
- ④ SQD SKRUE 4,2x45 [4034483]
- ⑤ SYNLIG I-FIX TRÆSKRUE 4,8x60
- ⑥ KRYDSFORSKALING AFSTANDSLISTE 25x100/25x50

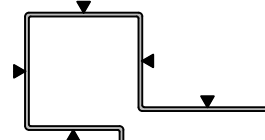

▼ MÆRKNING MALET SIDE.
SYMMETRISK UDVENDIGT HJØRNE

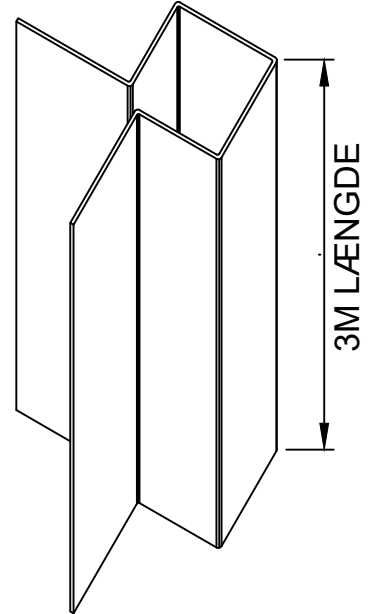

3M LÆNGDE

3 MM TIL BEVAEGELSE

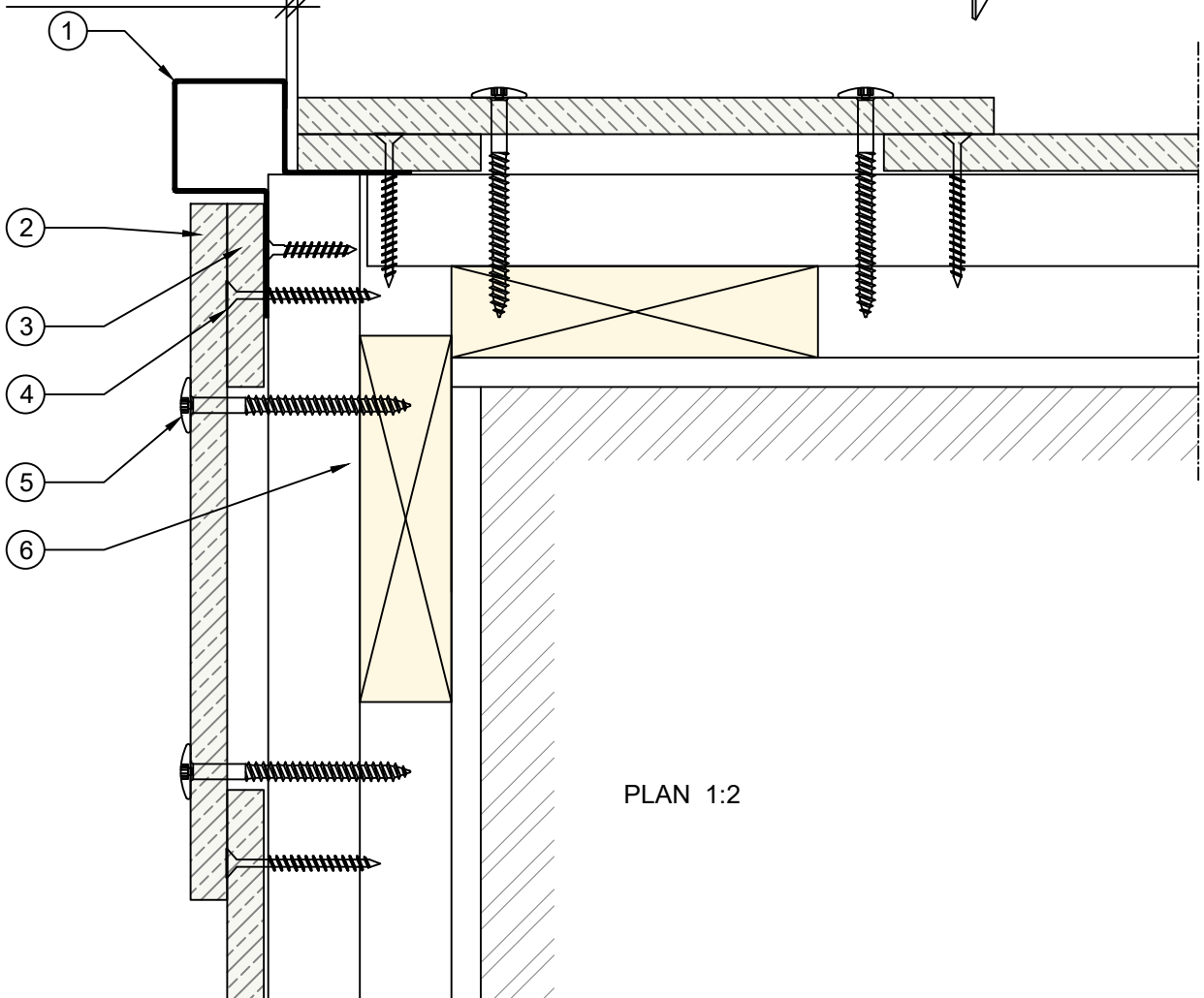

PLAN 1:2

FOR YDERLIGERE INFORMATION, VENLIGST KONTAKT:

INTERNET: WWW.CEDRAL.WORLD E-MAIL: etexnordic-dk@etexgroup.com TEL: +45 73 66 19 99

ETEX NORDIC A/S, VENDERSGADE 74, DK-7000 FREDERICIA

- ① SIDINDDÆKNING PROFIL
- ② EPDM BÅND FLAT
- ③ SQD SKRUE 4,2x45 [4034483]
- ④ KRYDSFORSKALING AFSTANDSLISTE 25x100/25x50
- ⑤ CEDRAL LAP

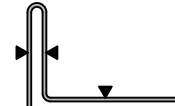

▼ MÆRKNING MALET SIDE.

SIDINDDÆKNING

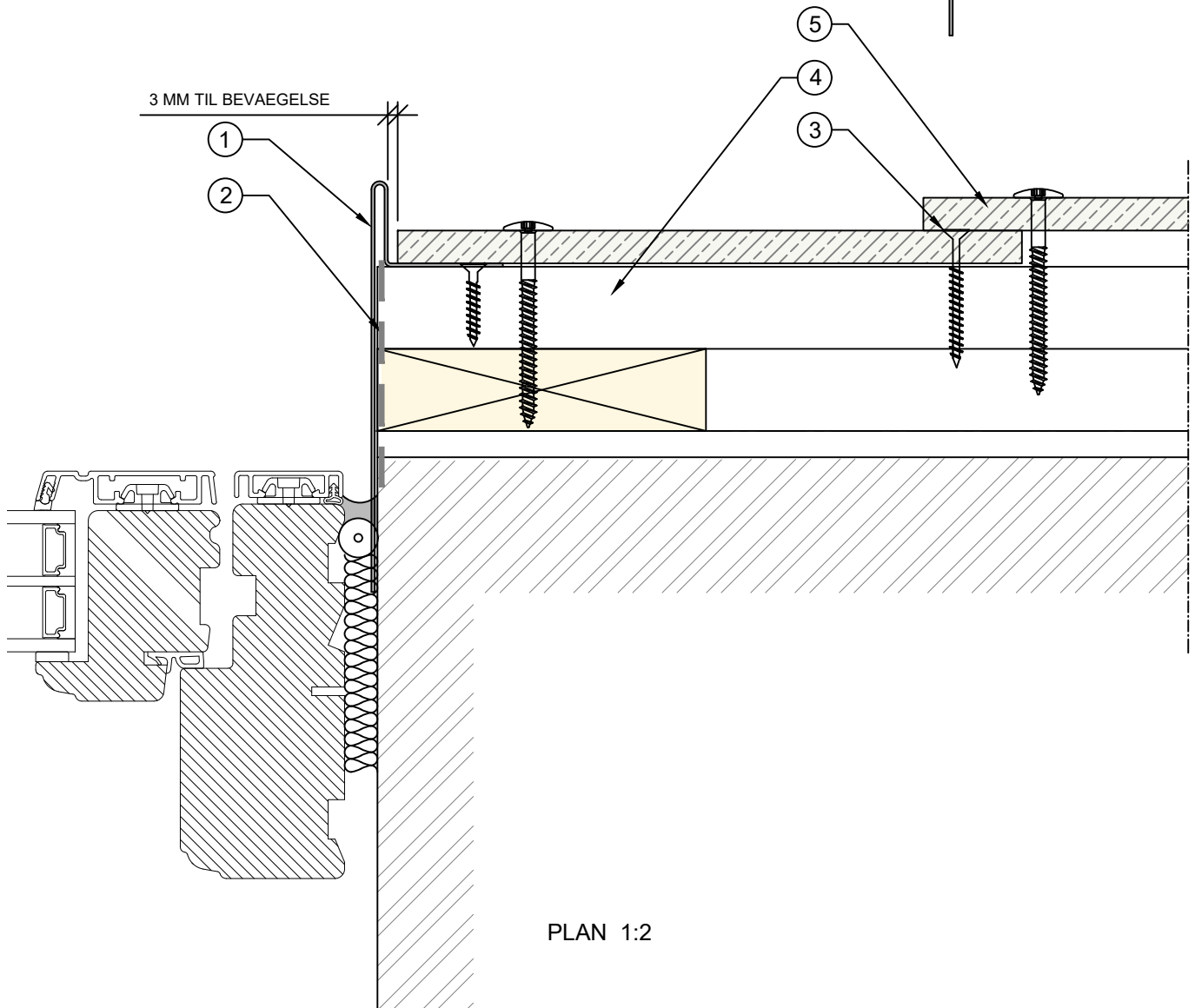

PLAN 1:2

FOR YDERLIGERE INFORMATION, VENLIGST KONTAKT:

INTERNET: WWW.CEDRAL.WORLD E-MAIL: etexnordic-dk@etexgroup.com TEL: +45 73 66 19 99

ETEX NORDIC A/S, VENDERSGADE 74, DK-7000 FREDERICIA

Copyright

This information is supplied in good faith but no liability can be accepted for any loss or damage resulting from use. All details and quantities must be checked and approved prior to order.

① ASYMMETRISK UDVENDIGT HJØRNE

② EPDM BÅND FLAT

③ SYNLIG I-FIX TRÆSKRUE 4,8x39

④ ENKEL ENDEKANT PROFIL

⑤ KRYDSFORSKALING AFSTANDSLISTE
25x100/25x50

⑥ CEDRAL LAP

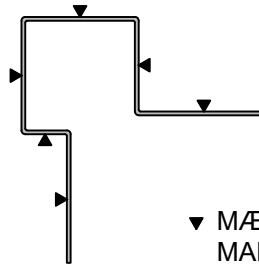

▼ MÆRKNING
MALET SIDE

ASYMMETRISK
UDVENDIGT HJØRNE

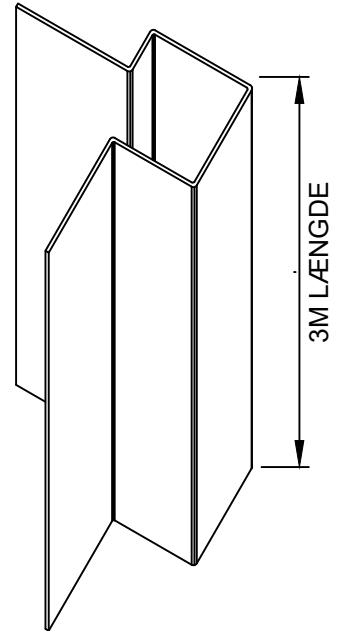

3 MM TIL BEVAEGELSE

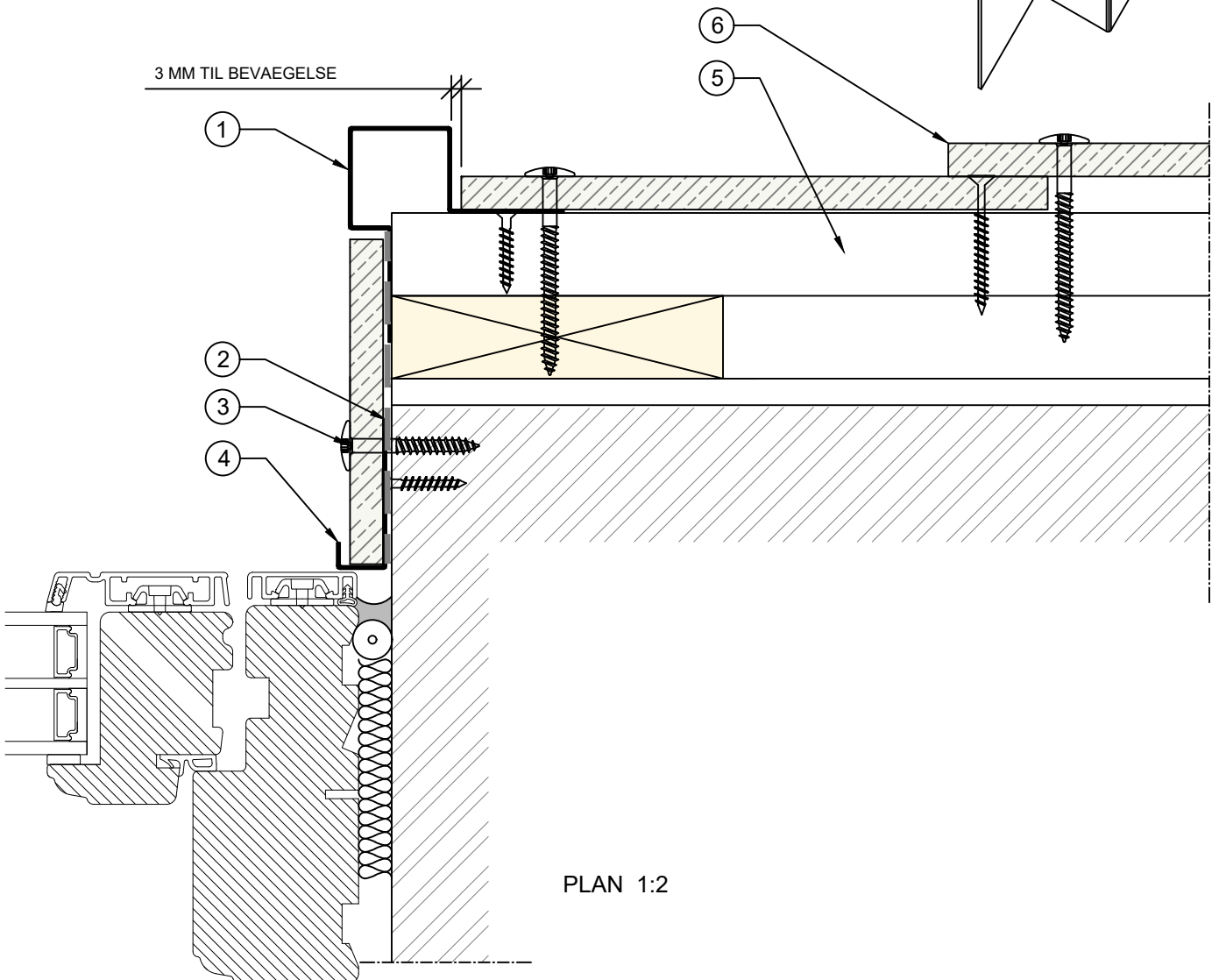

PLAN 1:2

FOR YDERLIGERE INFORMATION, VENLIGST KONTAKT:

INTERNET: WWW.CEDRAL.WORLD E-MAIL: etexnordic-dk@etexgroup.com TEL: +45 73 66 19 99

ETEX NORDIC A/S, VENDERSGADE 74, DK-7000 FREDERICIA

- ① SQD SKRUE 4,2x45 [4034483]
- ② CEDRAL LAP
- ③ KRYDSFORSKALING AFSTANDSLISTE 25x100/25x50
- ④ SYNLIG I-FIX TRÆSKRUE 4,8x60
- ⑤ INVENDIGT HJØRNE PROFIL

▼ MÆRKNING MALET SIDE.

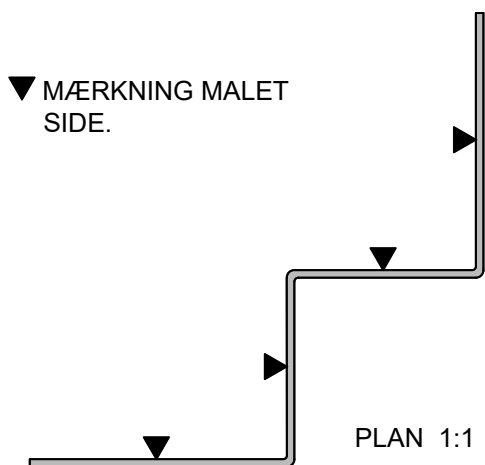

INVENDIGT HJØRNE

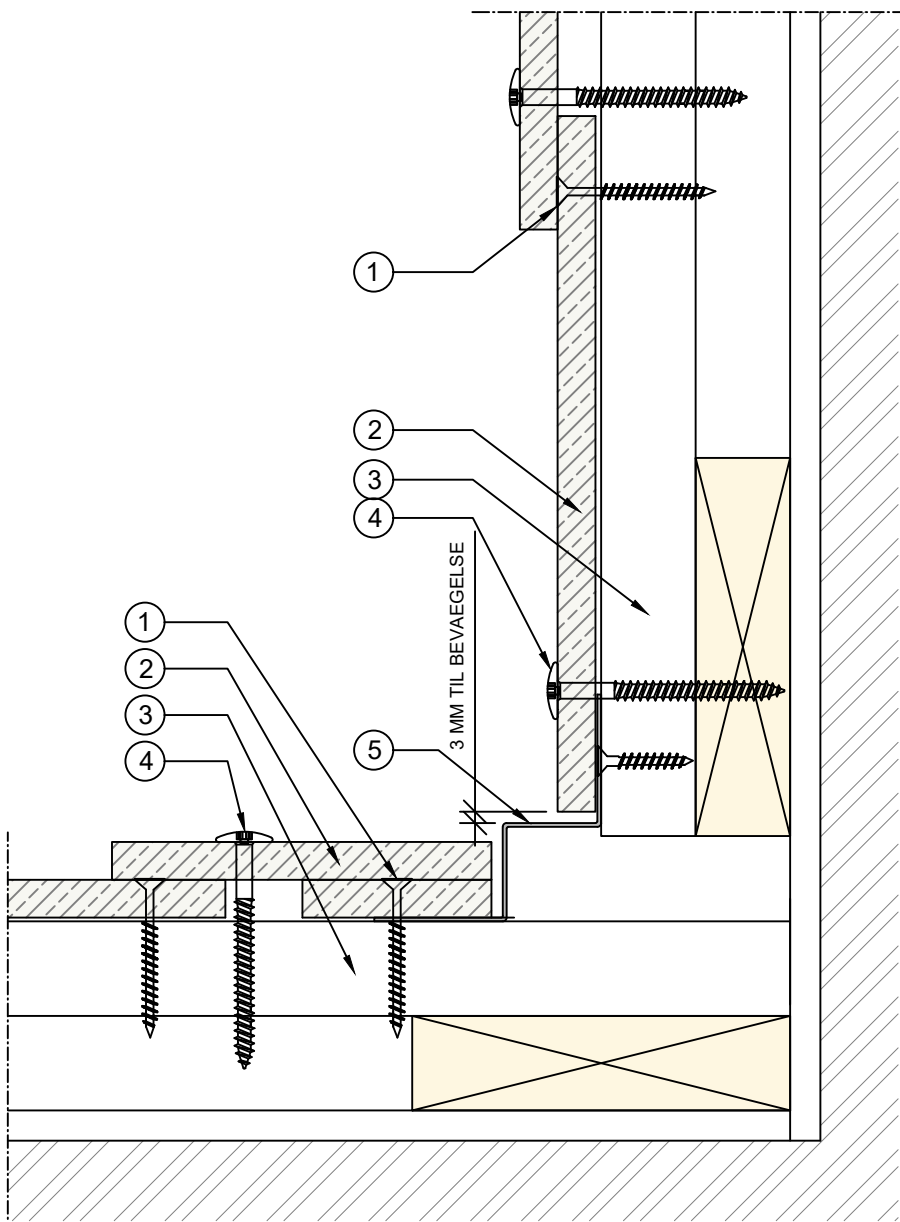
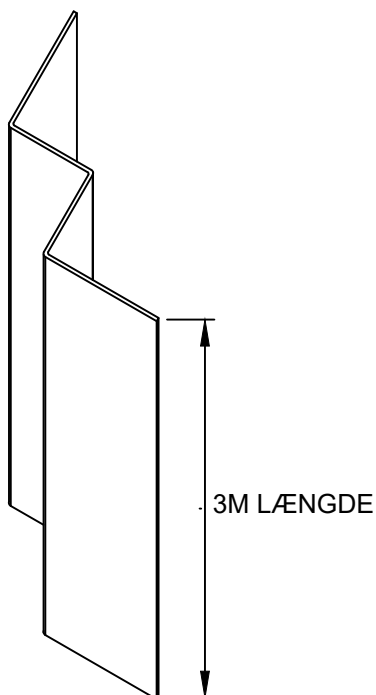

PLAN 1:2

FOR YDERLIGERE INFORMATION, VENLIGST KONTAKT:

INTERNET: WWW.CEDRAL.WORLD E-MAIL: etexnordic-dk@etexgroup.com TEL: +45 73 66 19 99

ETEX NORDIC A/S, VENDERSGADE 74, DK-7000 FREDERICIA

- ① CEDRAL LAP
- ② KRYDSFORSKALING AFSTANDSLISTE 25x100/25x50
- ③ SYNLIG I-FIX TRÆSKRUE 4,8x60
- ④ SQD SKRUV 4.2x45
- ⑤ DOBBELT ENDEKANTPROFIL

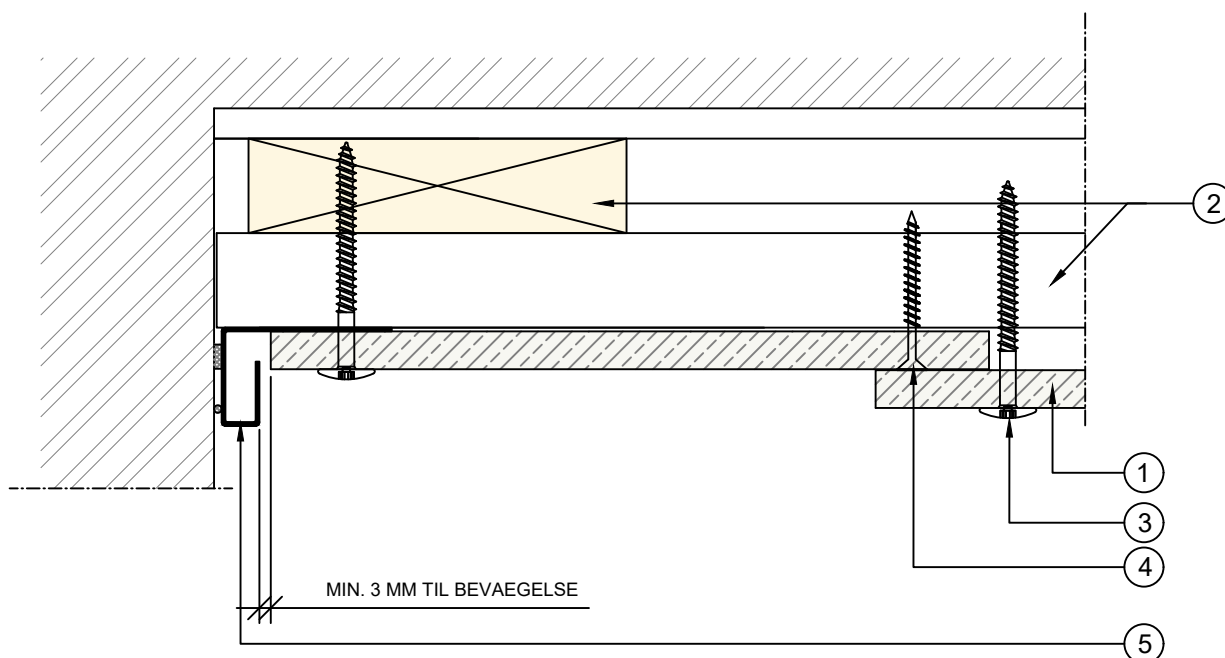

PLAN 1:2

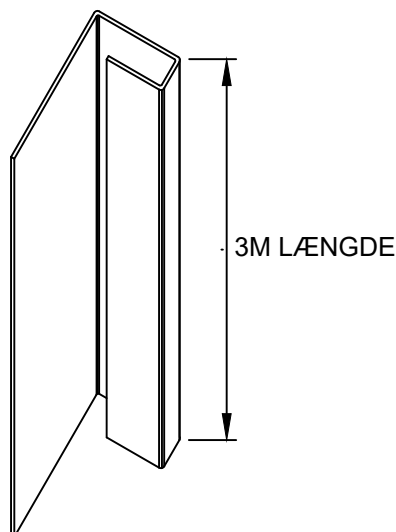
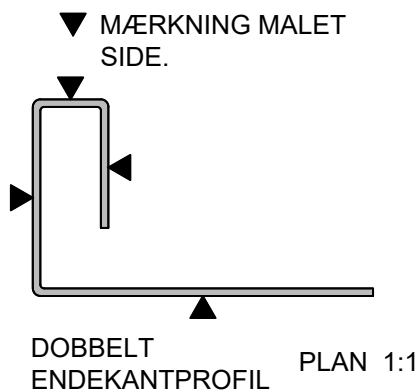

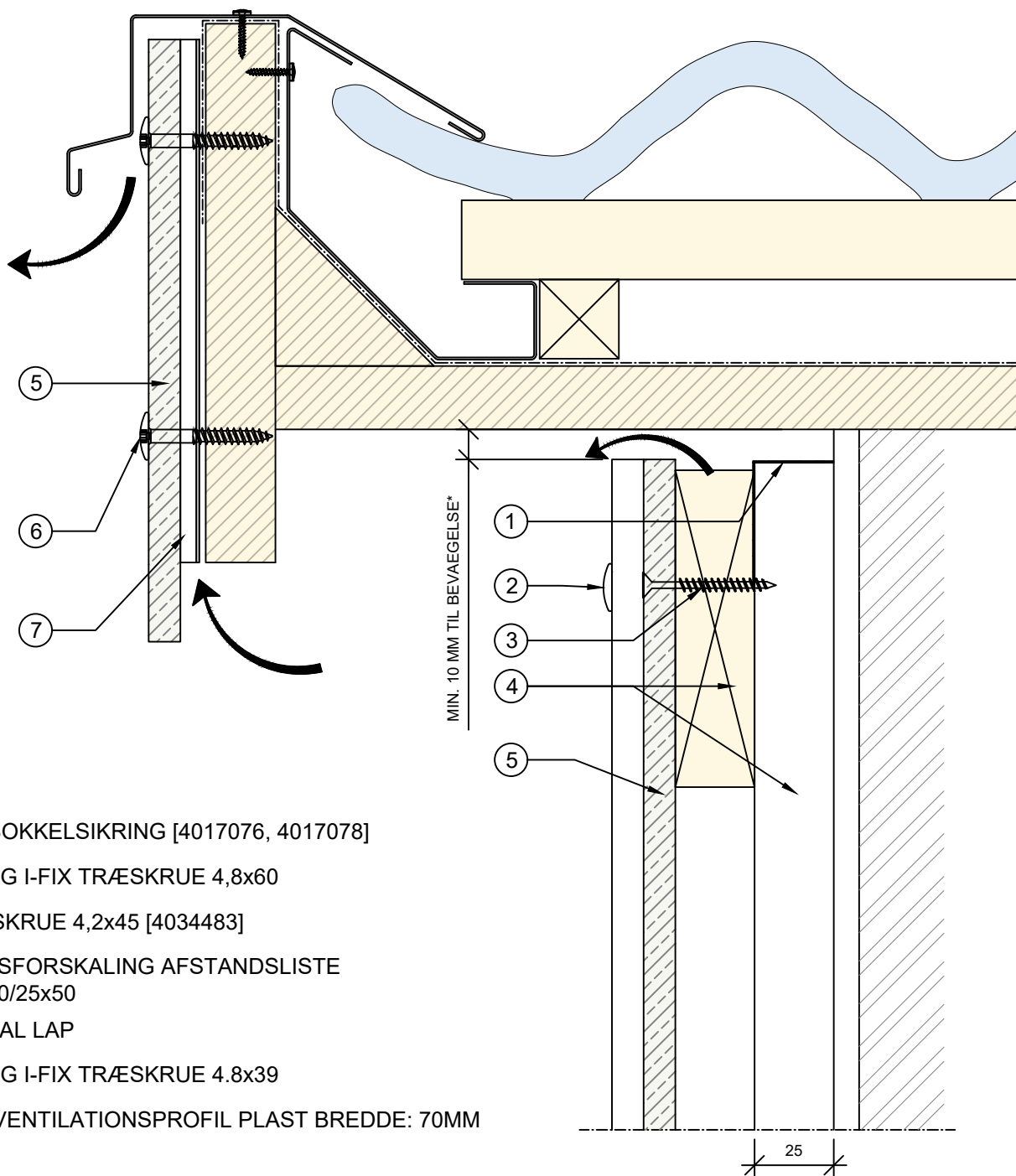

- ① ALU SOKKELSIKRING [4017076, 4017078]
- ② SYNLIG I-FIX TRÆSKRUE 4,8x60
- ③ SQD SKRUE 4,2x45 [4034483]
- ④ KRYDSFORSKALING AFSTANDSLISTE 25x100/25x50
- ⑤ CEDRAL LAP
- ⑥ SYNLIG I-FIX TRÆSKRUE 4.8x39
- ⑦ 6MM VENTILATIONSPROFIL PLAST BREDDE: 70MM

FOR YDERLIGERE INFORMATION, VENLIGST KONTAKT:

INTERNET: WWW.CEDRAL.WORLD E-MAIL: etexnordic-dk@etexgroup.com TEL: +45 73 66 19 99

ETEX NORDIC A/S, VENDERSGADE 74, DK-7000 FREDERICIA